

# ORCA<sup>®</sup>-Flash2.8

DIGITAL CAMERA

Low noise

**3 electrons**  
(r.m.s.)

High resolution

**2.8 megapixel**

High-speed readout

**45 frames/second**  
(1920 × 1440)

Up to **1273 frames/second**

High dynamic range

**4500: 1**



A breakthrough in scientific digital cameras,  
featuring the new Scientific CMOS Image Sensor FL-280

At its core, the ORCA-Flash2.8 is equipped with the new scientific image sensor FL-280, an advanced CMOS device that finally realizes the multiple benefits of high resolution, high readout speed, and low noise all at once. ORCA-Flash2.8 provides 2.8 megapixel resolution at 45 frames/second (and up to 1273 frames/second by sub-array readout) while achieving 3 electrons r.m.s. readout noise performance. Moreover, the ORCA-Flash2.8 delivers high sensitivity through its on-chip micro lens, 4500:1 high dynamic range, on-chip analog gain and various correction features that make the camera suitable for almost any scientific application from bright field imaging to low-light fluorescence imaging across a wide spectral range. Various external trigger functions and timing output functions ensure proper timing control with peripheral equipment to cover a wide range of applications.

ORCA-Flash2.8 is the new scientific digital camera for life science microscopy, semiconductor inspection, x-ray scintillator readout or industrial imaging.

## Applications

- High-speed Ca<sup>2+</sup> imaging
- Ratio imaging
- FRET
- TIRF microscopy
- Live cells expressing GFP
- Time lapse fluorescence imaging
- Micromorphological observation
- Real-time confocal microscopy
- Fluorescence in situ hybridization (FISH)
- Failure analysis
- Semiconductor inspection
- X-ray scintillator readout

**HAMAMATSU**

PHOTON IS OUR BUSINESS

## High-speed readout with low noise

### Lower readout noise than cooled CCD camera

Scientific CMOS Image sensor FL-280 realizes low noise performance through its on-chip CDS circuit. It achieves 3 electrons r.m.s. readout noise performance, which is better than the conventional cooled CCD image sensor technology. The lower readout noise characteristic improves the low light detection limit.

### Low noise and fast readout time simultaneously

The FL-280 realizes both low noise and high speed readout simultaneously due to its one-line parallel simultaneous readout using column A/D converters. While keeping very good low noise performance, it achieves high resolution and fast readout simultaneously. Without sacrificing the noise characteristics, it also offers a large field of view, high resolution and high speed imaging. Moreover, the sub-array feature is available to provide max. 1273 frames/s without sacrificing the readout noise performance.

Readout method	Number of pixels	Readout speed (frames/second)
Full resolution	1920(H) × 1440(V)	45.4
Sub-array readout (Typical examples)	1920(H) × 1080(V)	60.0
	1920(H) × 600(V)	104.6
	1920(H) × 240(V)	236.8
	1920(H) × 80(V)	540.0
	1920(H) × 8(V)	1273.6

### Low dark current

Dark current in the ORCA-Flash2.8 is very well suppressed through +5 °C cooling with a peltier element (thermoelectric cooling device).

### High image quality (no fixed pattern noise)

The FL-280 has readout amplifiers in each pixel and each column. Thanks to an advanced semiconductor manufacturing process, the differences in output among these amplifiers is greatly minimized. As a result, there is no fixed pattern noise, which is a typical blemish on images captured with conventional CMOS image sensors.

#### Comparison of noise performance (no image correction)

● Conventional CMOS camera

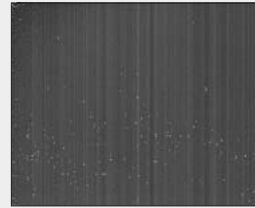

▲ Exposure time: 15 ms

● ORCA-Flash2.8

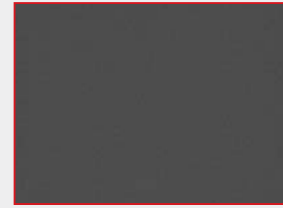

▲ Exposure time: 50 ms

## Pixel size and field of view

### About twice the resolution of CCD (2/3 inch, 1.3 megapixel)

At 2.8 megapixel, the FL-280 has about twice resolution of the conventional CCD (2/3 inch, 1.3 megapixel) used in the ORCA-R2. Pixel size is 3.63 μm × 3.63 μm, which is about half of the conventional CCD image sensor (2/3 inch, 1.3 megapixel).

### Wider field of view than CCD (2/3 inch, 1.3 megapixel)

Even though the pixels are less than half the size, because the FL-280 has twice the number of pixels it can provide a wider field of view than the conventional CCD image sensor (2/3 inch, 1.3 megapixel).

\* Using a 0.5x relay lens in microscopy results in the same numbers of photons per pixel as with a CCD image sensor (2/3 inch, 1.3 megapixel).

#### Comparison of resolution

● Bright field observation (Sample: Diatom Test Plate, Objective lens: Plan Apo 40x)

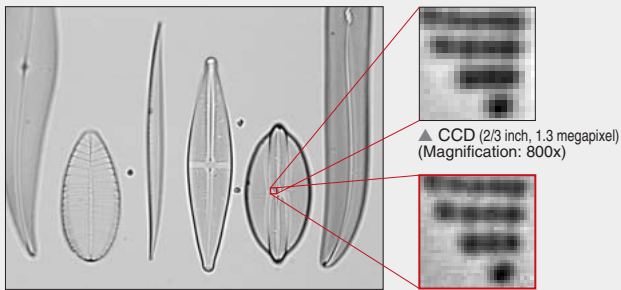

▲ Entire image

▲ ORCA-Flash2.8 (FL-280)  
(Magnification: 400x)

▲ CCD (2/3 inch, 1.3 megapixel)  
(Magnification: 800x)

#### Comparison of field of view

● Fluorescent observation (Sample: FluoCell prepared slide #2 (BODiPY), Objective lens: Plan Apo 40x)

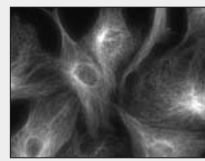

▲ CCD (2/3 inch, 1.3 megapixel)  
(without relay lens)

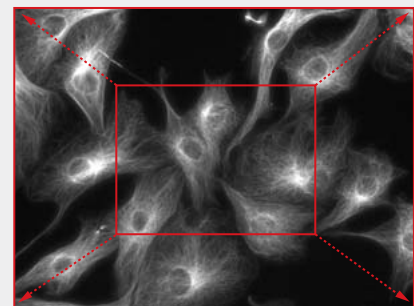

▲ ORCA-Flash2.8 (FL-280) (0.5x relay lens used)

## Excellent linearity (incoming photons vs. output signal)

### Linearity

The linearity characteristic is necessary to detect signals faithfully. In the ORCA-Flash2.8, the linearity between incoming photons and the output signal is secured through the FL-280 and its optimized circuitry.



#### Linearity characteristics

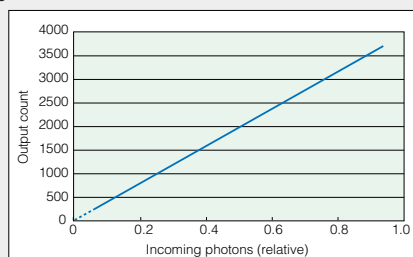

## ○ Analog gain

### Ideal for low-light imaging at short exposures

The ORCA-Flash2.8 features an on-chip gain control capability that can multiply the analog signal prior to converting it into a digital signal. This has the effect of reducing the quantization error in the A/D converter, and the readout noise can be lowered to 3 electrons (r.m.s). When low-light sample imaging in a short time is necessary and the output signal level is only a few to a few dozen ADU, the image quality can be improved by increasing the analog gain.

### Comparison (exposure time: 22 ms)

#### ● Analog gain 1x

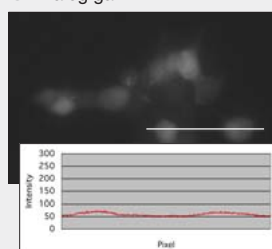

#### ● Analog gain 8x

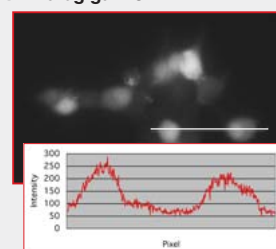

▲ These graphs show the intensity profile of the white line in each image.  
(Sample: Fluo-4-loaded Ins-1 cells)

## ○ Real-time correction features

### Shading correction, defective pixel correction

Image processing within the camera must take into account shading caused by illumination or optics. It must also handle the fact that a few pixels may have slightly higher readout noise than their surrounding pixels. To improve image quality against such factors, the ORCA-Flash2.8 is designed to perform dark correction, shading correction, and defective pixel correction on each pixel in real time.

## ○ Synchronization with peripheral equipment

### External trigger functions and timing output functions

In addition to edge trigger and level trigger functions, which are normally available in most digital cameras, ORCA-Flash2.8 has the following unique external trigger functions and timing output functions to manage the exposure timing of the camera and peripheral equipment. This helps achieve the best imaging in a wide variety of applications.

#### ● Global exposure trigger

The global exposure trigger is used for imaging with a pulsed light source such as pulsed laser or flash lamp. In this mode, the camera combines the frames right before and after the global exposure trigger signal into one frame.

#### ● Synchronous readout trigger

The synchronous readout trigger mode is used for continuous imaging when it is necessary to control the exposure start timing of each frame from an external source. Useful for laser confocal microscopy.

#### ● Start trigger

The start trigger is used so that the camera starts to work in internal trigger mode by an external trigger pulse. This is useful in luminescence imaging by an electrical stimulation without any dead time.

#### ● Trigger delay function

In each external trigger mode, the delay time can be set to the trigger signal input to the camera by commands.

#### ● Programmable timing output

Output pulses can be generated by command according to specified pulse widths or delay times. It acts as a simple delay unit or a simple pulse generator.

#### ● Global exposure timing output

Global exposure timing output shows the global exposure timing where all lines are exposed at the same time.

#### ● Trigger ready output

Trigger ready output shows the trigger ready period where the camera can accept an external trigger in the external trigger mode.

## Sample images

### ● High-sensitivity, high-resolution imaging

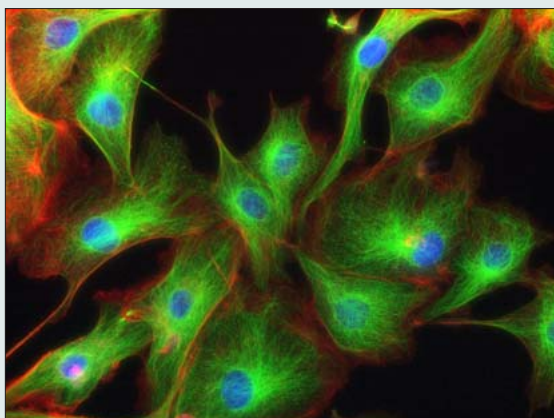

▲ Superimposed trichrome stain (Sample: FluoCells prepared slide #2)

### ● High-speed imaging

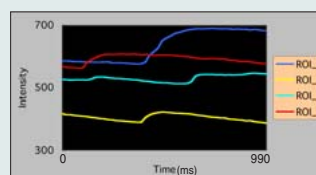
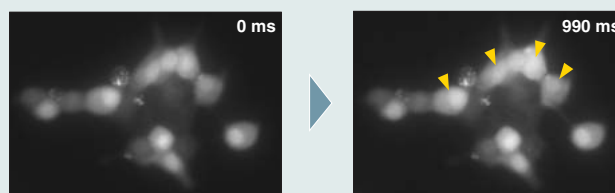

Top figure: Observation image

Left graph: Temporal  $[Ca^{2+}]_i$  dynamics (4 ROI)

Sample: Spontaneous  $[Ca^{2+}]_i$  change of Fluo-4-loaded Ins-1 cells  
Acquisition setting: 45 fps (exposure time: 22ms)

## System configuration

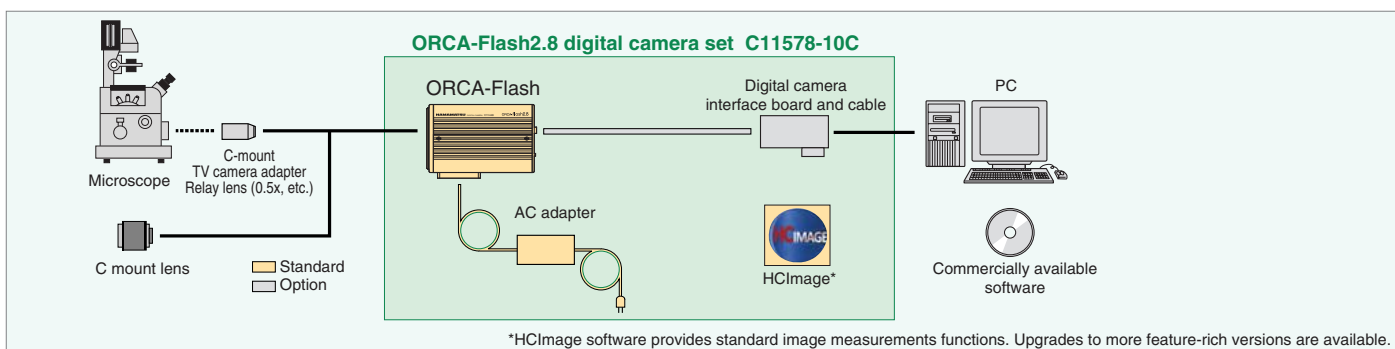

## Specifications

Type number	C11440-10C (ORCA-Flash2.8)	
Camera head type	Passive air-cooled head	
Imaging device	Scientific CMOS Image Sensor FL-280	
Effective number of pixels	1920 (H) × 1440 (V)	
Cell size	3.63 μm (H) × 3.63 μm (V)	
Effective area	6.97 mm (H) × 5.23 mm (V)	
Readout mode/speed	Full resolution	45.4 frames/s (1920 (H) × 1440 (V))
	Sub-array (Typical examples)	60.0 frames/s (1920 (H) × 1080 (V))
		104.6 frames/s (1920 (H) × 600 (V))
		236.8 frames/s (1920 (H) × 240 (V))
		540.0 frames/s (1920 (H) × 80 (V))
1273.6 frames/s (1920 (H) × 8 (V))		
Binning*	2 × 2	
Readout noise (r.m.s.) typ.	3 electrons (gain 8x)	
Full well capacity typ.	18000 electrons	
Analog gain	1x to 8x (256 steps)	
Dynamic range typ.**	4500: 1 (gain 1x)	
Cooling method	Peltier device + passive air-cooled	
Cooling temperature	+5°C (Ambient temperature: +20 °C)	
A/D converter	12 bit	
Exposure time	20 μs to 10 s (at internal trigger/external trigger)	
External trigger mode	Edge trigger, Level trigger Global exposure trigger Synchronous readout trigger, Start trigger	
Trigger delay function	0 μs to 10 s (10 μs step)	
Trigger output	Programmable timing output Global exposure timing output Trigger ready output	
Lens mount	C-mount	
Interface	Camera Link Base Configuration	
Connector	Mini-Camera Link	
Power requirements	AC 100 V to AC 240 V, 50 Hz/60 Hz	
Power consumption	About 45 V·A	
Ambient storage temperature	- 10 °C to + 50 °C	
Ambient operating temperature	0 °C to + 40 °C	
Ambient storage /operating humidity	70 % max. (no condensation)	

## ● Spectral response

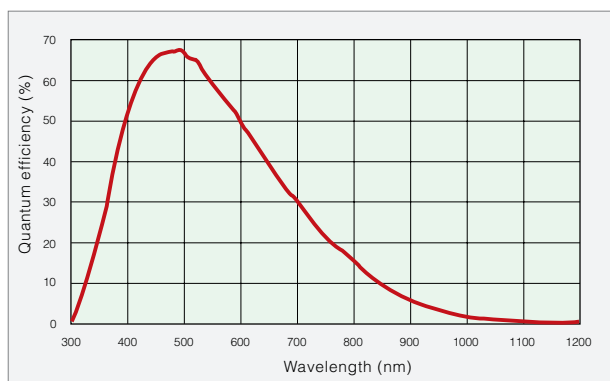

## Dimensional outlines

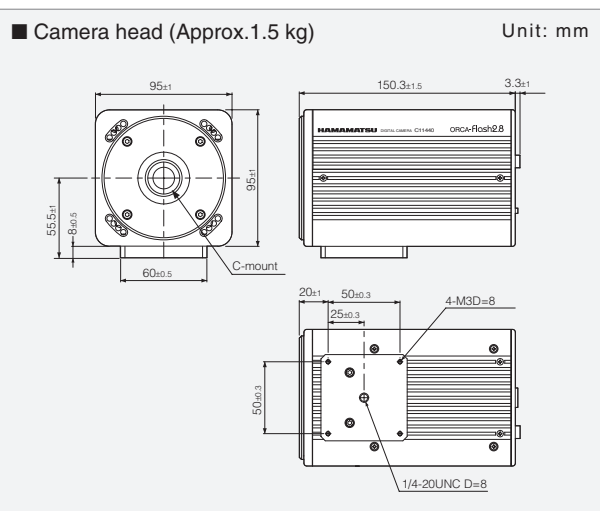

\*Digital binning processing in the camera

\*\*Calculated from the ratio of the full well capacity and the readout noise.

**ORCA is registered trademark of Hamamatsu Photonics K.K. (France, Germany, Japan, U.K., U.S.A.)**

**HClmage is registered trademark of Hamamatsu Photonics K.K. (Australia, China, EU, Japan, Norway, Singapore, Switzerland, U.S.A.)**

**Product and software package names noted in this documentation are trademarks or registered trademarks of their respective manufacturers.**

- Subject to local technical requirements and regulations, availability of products included in this promotional material may vary. Please consult your local sales representative.
- Information furnished by HAMAMATSU is believed to be reliable. However, no responsibility is assumed for possible inaccuracies or omissions. Specifications and external appearance are subject to change without notice.

© 2010 Hamamatsu Photonics K.K.

**HAMAMATSU PHOTONICS K.K.** [www.hamamatsu.com](http://www.hamamatsu.com)

**HAMAMATSU PHOTONICS K.K., Systems Division**

**812 Joko-cho, Higashi-ku, Hamamatsu City, 431-3196, Japan, Telephone: (81)5:**

**U.S.A.:** Hamamatsu Corporation: 360 Foothill Road, P. O. Box 6910, Bridgewater, N.J. 08807-0910, U.S.A., Tele

**Germany:** Hamamatsu Photonics Deutschland GmbH: Arzbergerstr. 10, D-82211 Herrsching am Ammersee, Ge

**France:** Hamamatsu Photonics France S.A.R.L.: 19, Rue du Saule Trapu, Parc du Moulin de Massy, 91882 Mas

**United Kingdom:** Hamamatsu Photonics UK Limited: 2 Howard Court, 10 Tewin Road Welwyn Garden City Hertfordshi

**North Europe:** Hamamatsu Photonics Norden AB: Thorshamnsgatan 35 16440 kista, Sweden, Telephone: (46)8

**Italy:** Hamamatsu Photonics Italia: S.R.L.: Strada della Moia, 1/E, 20020 Arese, (Milano), Italy, Telephone: (39)0

**China:** HAMAMATSU PHOTONICS (CHINA) Co., Ltd.: 1201 Tower B, Jianning Center, No.27 Dongsanhuan Beilu, Chaoy

**Ni**  
**TECH**

**(주)엔아이텍**  
**NEW INSTRUMENTS TECHNOLOGY**

**www.nitech.co.kr Tel. 02-6925-1048**